

# THE PROPANE PLANNER



Job site considerations  
Installation tips  
Appliances  
Upgrades



**PROPANE**  
EXCEPTIONAL ENERGY®



## Propane Gives You Energy to Sell.

Congratulations on considering propane for your construction project. As you get started with planning — setting a schedule, ordering appliances, hiring subcontractors — the information in this book will serve as your propane energy planner.

### The Basics

There are a few fundamental things you and your clients should know about propane:

- **It's clean energy.** Propane gives builders points under green building programs such as the National Green Building Standard™ and LEED (Leadership in Energy and Environmental Design) for Homes. Also, its low emissions make it an approved alternative fuel recognized by the Clean Air Act and the Energy Policy Act of 2005.
- **It reduces energy costs.** Propane appliances are typically far more efficient than their electric counterparts. An Energy Star-qualified propane tankless water

heater with an efficiency factor (thermal efficiency) of 82 percent, for instance, can save a homeowner up to 60 percent on his or her energy bill compared to a standard electric tank-type model, while providing an endless supply of hot water.

- **It supports today's lifestyle.** Propane provides homeowners with the modern amenities they want, including direct-vent indoor fireplaces and energy for outdoor living spaces.
- **It's easy to work with.** With propane, you're not at the mercy of a public utility, so you control your own timing. Propane also affords you great flexibility and portability — as a temporary heat source, for instance, while drywall is being finished.



### Clean and Safe

Propane is a domestically produced energy source — more than 95 percent of the propane used in the United States is produced here in North America.

Propane is produced during oil or natural gas processing. Its unique properties make it much cleaner than most other fossil fuels.

- **Low emissions.** The use of propane gives off less than half the greenhouse gas emissions that electricity does, considering that more than half of the nation's electricity is produced by coal-fired power plants.

- **Nontoxic.** Propane is nontoxic and insoluble in water. Because it's released as a gas, it doesn't spill, pool, or leave a residue. That means propane is not harmful to soil or water in the unlikely event of a release.

- **Designed for safety.** Typically used in gas form, propane is compressed as a liquid under pressure for transportation and storage purposes. A chemical odorant (ethyl mercaptan) is added to propane to help detect leaks. Propane installation and service personnel are well-qualified through programs such as the Certified Employee Training Program.

### Greenhouse Gases: Propane Performs Strongly

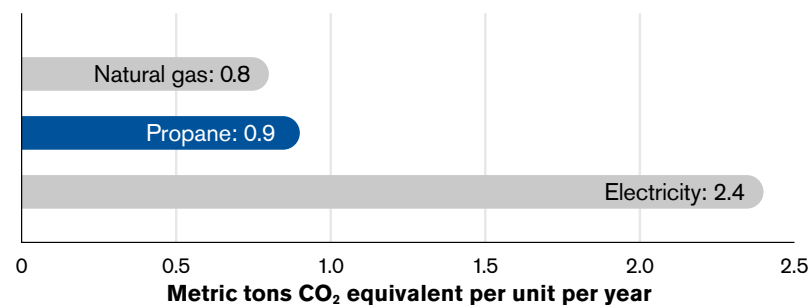

### Earn Points Toward Green

Propane can earn you more than 100 points toward the NAHB (National Association of Home Builders) National Green Building Standard, which incorporates environmental considerations into every phase of the home building process, from lot design and preparation to construction to homeowner education. Building with propane, in fact, can get your project nearly halfway to qualifying as a green home under the standard, just one of hundreds of green building programs in which propane performs well.

### Propane and the National Green Building Standard

You can learn more about the National Green Building Standard at [nahbgreen.org](http://nahbgreen.org).

	Maximum points from propane	Bronze	Silver	Gold	Emerald
Lot Design, Preparation, and Development	10	39	66	93	119
Resource Efficiency	8	45	79	113	146
Energy Efficiency	53	30	60	100	120
Water Efficiency	3	14	26	41	60
Indoor Environmental Quality	20	36	65	100	140
Operation, Maintenance, and Building Owner Education	7	8	10	11	12
Additional Points (from any section)	n/a	50	100	100	100
<b>Total Points</b>	<b>101</b>	<b>222</b>	<b>406</b>	<b>558</b>	<b>697</b>

Source: Points and categories based on the National Green Building Standard, ICC700-2008, approved by the American National Standards Institute on Jan. 29, 2009.



**Community Tanks**

Can a centralized community tank benefit your development project? Learn more at [buildwithpropane.com](http://buildwithpropane.com).

# Propane Is Always a Custom Fit.

When it comes to job-site planning, there are four major steps that your propane retailer or subcontractor will walk you through to ensure you get the right tank and pipe configuration for your customer's needs.

## STEP 1: Determine Tank Size

There are two main types of propane tanks. DOT cylinders, familiar to homeowners with propane grills, are generally used above ground and typically don't contain more than 25 gallons or 100 lbs. of propane. Typical horizontal ASME tanks have a water capacity of 125 to 1,000 gallons, and they can be filled with propane to the 80 percent level. Propane tanks can be installed above ground, and there are also models that are safe to bury underground, out of sight.

In the early stages of your project planning, one of the important questions you'll need to answer is: What size tank does my project demand? Your propane retailer is trained to assess and meet your project requirements, but you'll be better informed by keeping these rough guidelines in mind.

PROJECT SIZE	TANK TYPE	TANK SIZE
Single appliance	DOT or ASME	Up to 125 gallons
Standard four-bedroom home	ASME	500 gallons
Large home with multiple gas appliances	ASME	1,000 gallons

Other factors influencing tank size are the total square footage of the home, total BTU load of installed propane appliances, and the climate zone.



## STEP 2: Determine Tank or Cylinder Placement

The next question you'll be asking is: Where should the tank get placed? When selecting a location for the placement of a DOT cylinder or ASME storage container, you should evaluate only accessible, safety-approved sites. Considerations should include:

- **Building and safety codes:** These vary from location to location. Precedence must be given to state and local regulations and the *National Fire Protection Association (NFPA) 58: Liquefied*

*Petroleum Gas Code.* Your propane professional will refer to these standards when planning placement of your containers. Extra copies are available from the NFPA, Batterymarch Park, Quincy, MA 02269. Generally, tanks fall under a 10-foot rule with regard to clearance from the home and other structures. There are additional distance requirements for regulators and other considerations that your propane retailer will determine for you.

- **Ease of access:** Delivery trucks will need adequate access to refill the tank in all seasons.
- **Customer's desires:** Aesthetics play an important part in project success. Be sure to review the availability of underground and above-ground propane tanks with your customer. This is also the time to discuss overall site design, aesthetics, and landscaping.

<sup>1</sup>The chart at the top of the following page is reprinted with permission of *NFPA 58: Liquefied Petroleum Gas Code*, copyright ©2007, National Fire Protection Association, Quincy, MA 02269. This reprinted material is not the complete and official position of the NFPA on the referenced subject which is represented only by the standard in its entirety.

## Location of ASME containers

Tanks and gas lines require adequate clearance from ignition sources.<sup>1</sup>

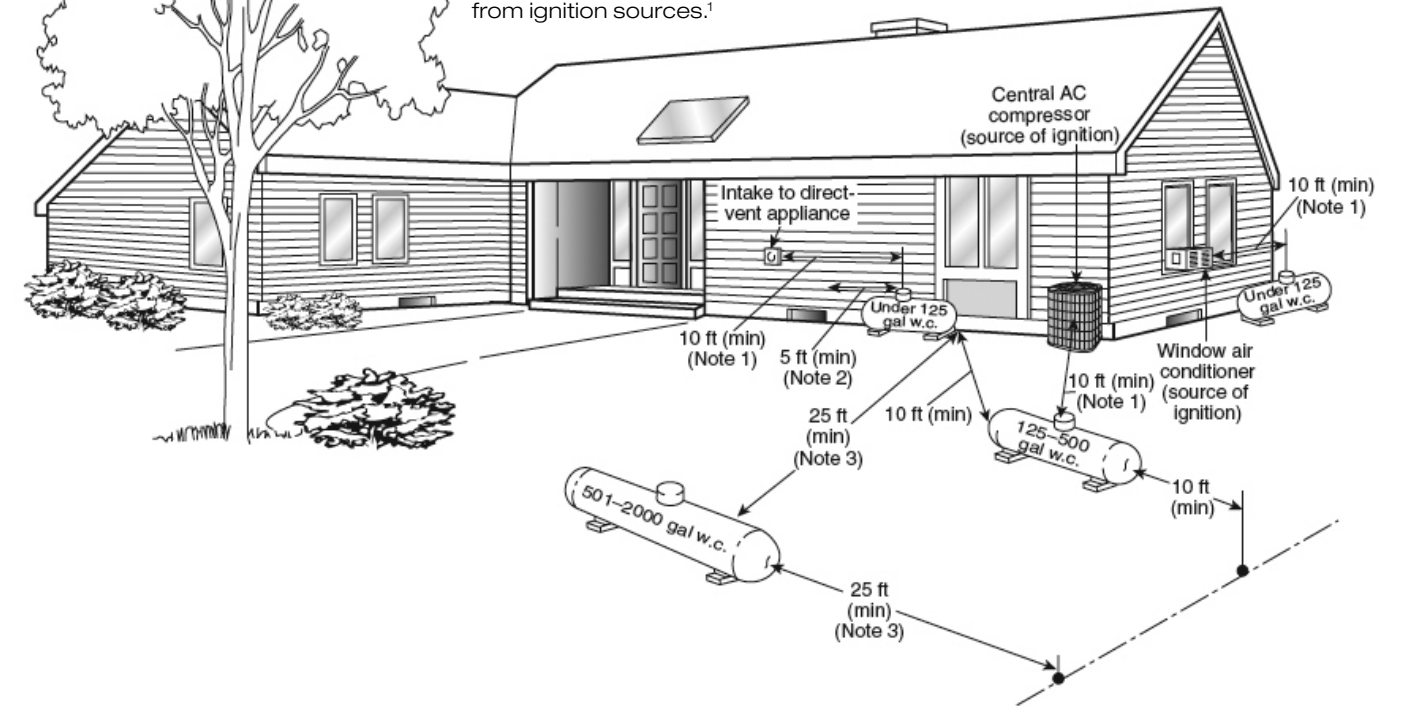

## STEP 3: Permitting and Tank Installation

Propane tank installation permits, if required, may be a part of the project permit process or may be required to be handled separately. Your propane retailer can advise you and perform the tank installation. In the case of new construction and underground tank placement, it's not uncommon for a propane retailer to have the septic company or other excavation contractor already on site dig the hole for the underground tank.

## STEP 4: Regulator Placement

Regulators come with pipe size and distance requirements just like tanks. Regulators can't be placed closer than 3 feet horizontally from any building opening, such as a window well, nor can they be placed closer than 5 feet from any source of ignition, such as an AC compressor. Check with your propane retailer to ensure you're in compliance.

## TIMELINE

While the timing on projects is never exactly the same, here's where propane would typically fit into your overall build schedule.

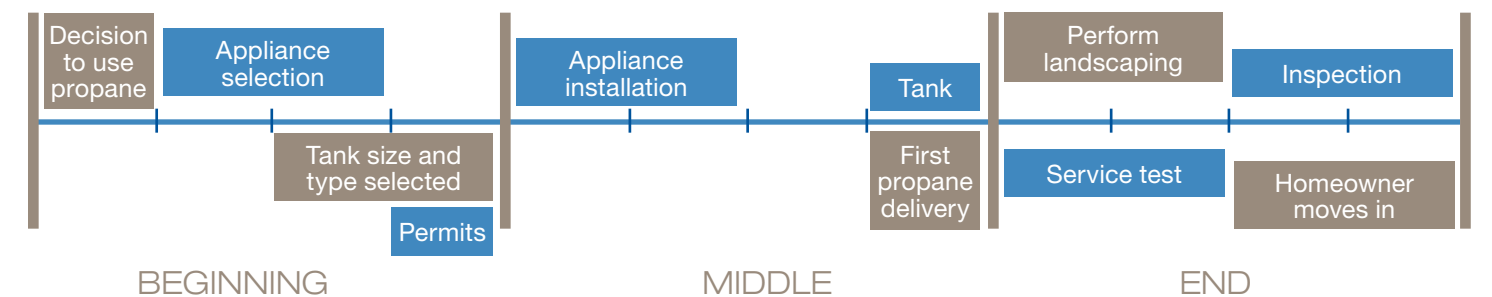



## Propane Water Heaters Are Hot.

Want to know where your homeowner's energy costs are going? Just turn the hot-water faucet. The U.S. Department of Energy estimates that approximately 20 percent of a home's energy costs are spent heating hot water. That's why helping your homeowner select an efficient water heater is critical — and when it comes to water heaters, electricity simply can't compete.

There isn't a single electric water heater that qualifies for the federal Energy Star program, while propane tankless units and many tank-type propane models do qualify. By choosing a standard or tankless propane water heater instead of an electric water heater, a homeowner can reduce energy costs by as much as 60 percent.

A standard propane water heater works in the same way as a natural gas water heater. A propane tankless water heater, however, is an "on-demand" system. When a homeowner opens a hot-water tap, the unit senses the demand and initiates the heating process.

The water flows through a heat exchanger, where it heats to the homeowner's desired temperature. When the faucet is closed, the heater automatically shuts off. Tankless water heaters are priced as low as \$600 plus installation, depending on size and volume of water-heating demand, and are widely available through many propane retailers and plumbing professionals.

### Fixture Flow Rate in Gallons per Minute

To select the right tankless unit, add up the gallons per minute estimated for the household during peak demand and match it to the EnergyGuide label on the water heater.

Bathtub	2.0–4.0
Shower	1.5–3.0
Kitchen sink	1.0–1.5
Laundry sink	2.5–3.0
Dish washer	1.0–3.0

#### Water Heating With Propane

To take a free online education course, visit [buildwithpropane.com](http://buildwithpropane.com).



### Installation Tips

Propane tankless water heaters are easy to install and use the same plumbing as natural gas units. They're typically direct-vent models that use a fan to power-vent vertically or horizontally. (This fan may require a minimal electrical connection.)

For both tankless and standard propane water heaters, proper installation depends on many factors including unit placement, climate, and local building code. To ensure you're properly venting your unit, refer to the manufacturer's instructions that come with the unit.

If you're not a qualified HVAC contractor or plumber, you'll want to make sure you're working with one.

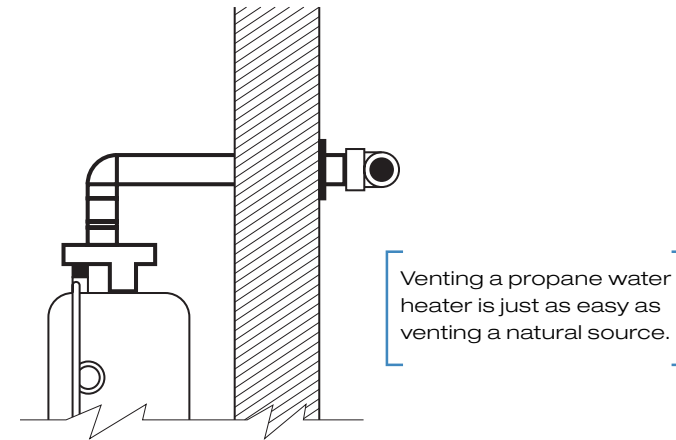
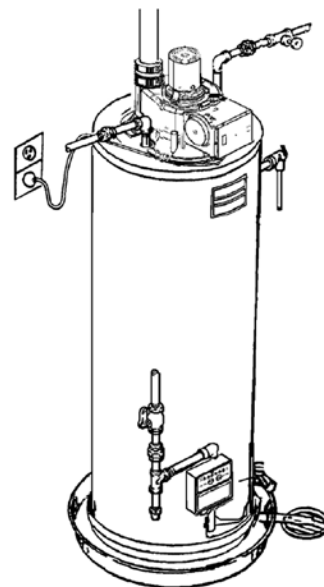
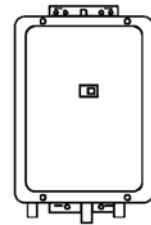

### Maintenance Tips

A propane water heater needs little maintenance — just an annual checkup from an appliance professional or whatever the manufacturer recommends. Because a propane tankless water heater doesn't need to maintain a stored water supply, it's less subject to corrosion. That means most tankless water heaters have a life expectancy of more than 20 years, compared with 5–10 years for a standard model. A standard model also is more labor-intensive to replace, isn't recyclable, and takes up a lot of space in landfills.

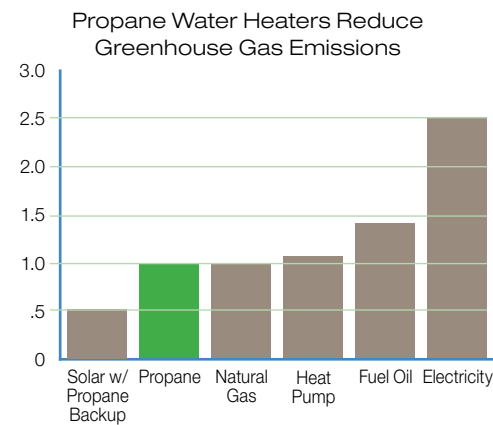

## 5 Benefits of Tankless Propane Water Heaters

- 1 Reduce energy costs.** They can reduce energy costs by up to 60 percent and eliminate standby energy loss.
- 2 Qualify for tax credits and other incentives.** See page 27 for details on additional savings.
- 3 They're durable.** A tankless propane unit will typically last five to 10 years longer than a standard electrical unit.
- 4 Reduce your footprint.** A tankless propane unit saves 12–16 square feet of floor space compared with a standard 50-gallon electric water heater.
- 5 They're environmentally friendly.** Propane is greener than electricity, considering that most electricity is created from coal-fired power plants. A propane tankless water heater will emit 35,000 lbs. fewer greenhouse gases over a 10-year period than will a standard electrical unit.



## Features That Homeowners Really Warm Up To.

Propane provides more versatility, affordability, and home comfort than any other heating choice — it's that simple. Propane home-heating systems can be configured as central or zone, forced air or radiant. Best of all, propane systems can help a homeowner slash energy costs and greenhouse gas emissions. Here are a few considerations for your project, many of which are available in Energy Star-qualified models.

### Heating Systems Analysis

To take a free online education course, visit [buildwithpropane.com](https://buildwithpropane.com).

- **Propane Furnaces.** Like a natural-gas furnace, a propane furnace cycles on and off, using a fan or blower to force heated air through ducts throughout the home. High-efficiency models are available with DC-current motors and multi-stage burners to further increase efficiency. Propane furnaces come in all shapes and sizes and have a typical operating life of 15 years or longer.
- **Radiant Floor Heating.** A propane water heater or boiler heats water that is pumped through a floor tubing system. By delivering more even heat, and more heat closer to the floor, these systems can be far more energy efficient and comfortable than a heat pump or furnace-and-duct system.
- **Fireplaces and Log Inserts.** These can be turned on and off with a thermostatic switch or remote control and heat a room more evenly and efficiently than wood-burning fireplaces. Most models are virtually maintenance-free, don't produce ash or soot, and don't require electricity. Direct-vent models also qualify for green building programs. (See page 19 for more.)
- **Hearth Stoves.** A free-standing propane stove produces instant radiant heat and adds aesthetic value to a room. Venting options make installation easy and flexible.
- **Space Heaters.** Propane space heaters can be free-standing or wall-mounted, can include thermostats and blowers, and typically work even in an electrical outage. They also produce fewer greenhouse gases than space heaters using fuel oil.

## 4 Benefits of Propane Home Heating

- 1 **Comfort.** A propane furnace can heat air up to 25 degrees warmer than electricity. Propane radiant heat can improve air quality in a home by cutting down on the spread of dust and allergens.
- 2 **Flexibility.** Propane appliances can go anywhere, and can be vented vertically or horizontally — perfect for homeowners who want more freedom, or to avoid the expense or square-footage required by a chimney.
- 3 **Homeowner preference.** Propane home heating is dependable and convenient. Most homeowners prefer propane or natural gas appliances, instead of electric ones.
- 4 **Environmentally smart.** A propane furnace or water heater emits far fewer greenhouse gases over a 10-year period than will standard electric-powered units.





## Propane in the Kitchen. Now You're Cooking.

Propane can provide energy to any room in the house, including the kitchen and laundry room. That's welcome news to homeowners, who tend to prefer gas appliances to their electric counterparts.

**Cooktops and ovens.** According to the American Gas Association, 96 percent of chefs prefer cooking with gas. You can indulge your homeowner's inner gourmet by recommending a commercial-grade propane cooktop and oven. Propane cooktops provide better heat control and more even heat distribution than electric. Instant-on burners allow cooking to start right away, without having to wait for a burner to heat up. They also cool more quickly, preventing overcooking and reducing the safety risk.

**Dryers.** Propane dryers operate and vent much the same as electric dryers but save homeowners time and energy with more-sophisticated performance capabilities. Steam dryers use a combination of steam and heat to relax wrinkles and remove odors, producing a ready-to-wear garment.

## 3 Benefits of Propane in the Kitchen and Laundry

- 1 High design.** Propane cooktops, ranges, and ovens are available in the most sophisticated styles, including commercial-grade stainless steel.
- 2 Delicious results.** From instant heat to more even heat, propane allows homeowners to cook like a pro.
- 3 Green.** A propane kitchen or laundry appliance will produce far fewer greenhouse gases than an electric one, considering that most electricity is produced by coal-fired power plants.



## A Propane Fireplace Can Stoke Sales.

A house isn't a home without a hearth. That's why homeowners demand gas fireplaces — and are willing to pay for them. They value their warmth, luxury appeal, efficiency, and the resale value they add to their property. Homeowners also increasingly prefer the convenience of a gas fireplace to a traditional wood-burning one.

### Options and Installation

All wood-burning fireplaces need vertical venting for their noxious combustion gases. Propane fireplaces, however, produce far fewer pollutants and come with more flexible venting options — including vent-free models that are highly valued in some remodeling projects. Most units come as ready-to-install fireboxes.

### Direct-Vent Fireplace

- **How it works:** uses a sealed combustion chamber to draw air from the outdoors and vent combusted gases back outside.
- **Perfect for** homeowners who are looking to maximize efficiency and warmth. There are many models to choose from that have been approved for use in green-building programs such as the National Green Building Standard and LEED for Homes.

### Power-Vent Fireplace

- **How it works:** An electric fan allows the unit to vent vertically or horizontally from locations where a conventional flue is either impractical or not desired.
- **Perfect for** situations in which aesthetics are of primary importance. You can place some models as far as 100 feet from an outside wall.

### Hearth Stove

- **How it works:** A sealed combustion chamber vents combusted gases through a dedicated chimney or chimney liner.
- **Perfect for** homeowners looking for classic charm and free-standing retrofits. Direct-vent models are also available.

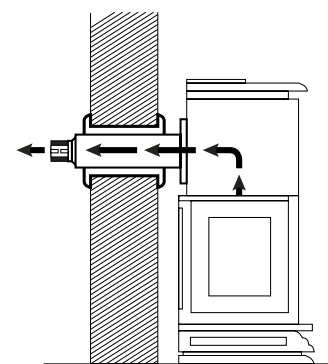

Direct-vent propane fireplaces and hearth stoves send combustion out while keeping warm air in.

## 4 Benefits of Propane Fireplaces

- 1 **Cost-effective installation.** They don't require the expensive masonry or metalwork of a chimney.
- 2 **Budget-friendly operation.** According to the U.S. Department of Energy, a propane fireplace costs 30 percent to 60 percent less to operate than a wood-burning fireplace.
- 3 **Efficient operation.** A wood-burning fireplace can lose as much as 90 percent of the heat it generates by venting heated room air up the chimney. Propane fireplaces and log sets can be up to 100 percent efficient.
- 4 **Environmentally smart.** Unlike a wood-burning fireplace, a propane fireplace doesn't produce ash, soot, or smoke.



## Propane Energizes Outdoor Rooms.

Outdoor living spaces can add just as much to a home's overall comfort and resale value as its indoor features. No longer just a deck and a floodlight, a comfortable and fully functional outdoor living area today includes an array of kitchen appliances, pools and spas, sophisticated lighting, and radiant heat. Propane has been a favorite outdoor energy source for decades. Thanks to manufacturers' new appliances, an outdoor living space can now be an extension of your home.

### Outdoor Rooms

To take a free online education course, visit [buildwithpropane.com](http://buildwithpropane.com).



### Outdoor Options

- **Grills.** Propane grills are push-button easy and 105 times more environmentally friendly than charcoal grills, according to the U.S. Environmental Protection Agency.
- **Cooktops, ovens, and other kitchen appliances.** Create a luxury, state-of-the-art kitchen outdoors.
- **Hearth.** Environmentally friendly, weatherproof propane fireplaces allow homeowners to enjoy the great outdoors year round.
- **Patio heaters.** A standing or portable propane heater can raise the outdoor air temperature as much as 30 degrees nearby.
- **Pool and spa heaters.** Propane pool and spa heaters bring the water to the desired temperature more quickly and efficiently than an electric heater.
- **In-floor heating.** Perfect for making a patio more usable during the colder months.

- **Tankless water heater.** Propane heats water on demand for a poolside shower and outdoor laundry room. Propane clothes dryers are fast and efficient.
  - **Standby generators.** They're durable, environmentally friendly, and quiet. Many produce less than 60 decibels — as quiet as a normal conversation.
  - **Lighting.** Propane lighting is available in portable and mounted styles ranging from old-world to modern.
- New Plug1 outlets make connecting portable propane appliances as safe and easy as plugging in an electrical appliance.

### Installation Tips

Remember that tanks can be installed underground, out of sight. In applications where an above-ground tank makes the most sense, a subcontractor can install fencing and landscaping to dramatically improve aesthetics.

## 3 Benefits of Propane Outdoors

- 1 **History.** From grills to pool heaters, propane has a long history as a trusted outdoor energy source.
- 2 **Performance.** Propane can heat a pool faster than electricity and heat a grill faster than charcoal.
- 3 **Ease of use.** With few or no municipal utility connections required, propane makes enhancing a backyard space easy and cost-effective.



## The Lights Are On. Propane's Home.

In the past 10 years, the demand for electricity has increased exponentially due to population growth and the increased use of power-thirsty computers and flat-screen TVs. For homeowners in many areas, this has resulted in electrical outages that disrupt home comfort. While most outages last 20 to 30 minutes, a J.D. Power and Associates study put the average extended power outage at eight hours.

A standby generator can keep the electricity flowing — and food fresh — in the event of a power failure that results from a service disruption or a natural disaster. A propane generator can even serve as a primary energy source for homes built off the main, creating a reliable energy island. Combined heat and power (CHP) units are now available that produce heat in addition to electricity.

### Installation

Propane standby generators are housed outside, usually adjacent to a garage or other non-living space. Often air-cooled, they draw fuel from the home's propane storage tank.

## 4 Benefits of Propane Generators

- 1 **Quiet operation.** Many units produce fewer than 60 decibels of noise — as quiet as a normal conversation.
- 2 **Value.** A home insured against an electrical outage is more valuable to buyers.
- 3 **Dependability.** A 250-gallon propane tank and a seven-kilowatt standby generator can provide enough electricity to power a home for five days and hot water for bathing.
- 4 **Protection.** A propane generator can insulate a homeowner from food losses in refrigerators and freezers and keep heating and air conditioning systems operating normally.

## Propane Can Pay You Back.

Homeowners love to hear about the federal, state, and local rebates and incentives that are available to them for choosing propane. Builders, remodelers, and HVAC contractors who understand what credits and rebates are available to customers in their area can help their homeowners get the most for their budget. In many cases, a builder or homeowner can get multiple credits and rebates for a single project.

Type of rebate or credit	Where you can learn more
<b>Federal tax credits</b> <ul style="list-style-type: none"> <li>• <b>For homeowners,</b> there's a credit for the installation of qualifying propane appliances.</li> <li>• <b>For home buyers,</b> there's an \$8,000 tax credit for first-time home buyers who buy a qualifying energy-efficient home.</li> <li>• <b>For builders,</b> there's a \$2,000 tax credit for building a qualifying energy-efficient home.</li> </ul>	buildwithpropane.com
<b>State and local government incentives</b> <p>Some states and localities provide tax credits, rebates, grants, and other incentives for propane projects.</p>	dsireusa.org
<b>State or regional propane association rebates</b> <p>Your local propane association may provide additional rebates to homeowners and builders for qualifying installations.</p>	buildwithpropane.com

## Additional Valuable Resources Online

At **buildwithpropane.com** you can find more resources like the ones found in this booklet, including:

- Information on emerging propane equipment technology such as freewatt systems and micro-CHP.
- Hybrid uses of propane.
- Online education resources.
- White papers and other research.



Whatever your project plan, and whatever your customer's needs, there's a propane appliance ready to deliver comfort, energy savings, and environmentally friendly performance.



- a Garage**
  - Space heater
  - On-demand hot water
- b Laundry**
  - On-demand hot water
  - Clothes dryer
- c Kitchen**
  - Commercial-style cooktop and oven
  - On-demand hot water
- d Bathroom**
  - On-demand hot water
  - Radiant-floor heating
  - Direct-vent fireplace
- e Living room**
  - Direct-vent fireplace
- f Bedroom**
  - Direct-vent fireplace
- g Basement/utility room**
  - Tankless water heater
  - Propane furnace or boiler
- h Backyard**
  - Outdoor kitchen and grill
  - Pool and spa water heaters
  - Gas lights, torches
  - Outdoor fireplace, fire pit

## Top 3 Benefits of Propane for Construction Professionals

- 1 Create home comfort.** Propane powers high-performance, state-of-the-art home features, including radiant-floor heating, on-demand hot water, outdoor living, and more.
- 2 Reduce energy costs.** Some propane appliances can save your customers up to 60 percent on their energy bills compared with standard electric appliances.
- 3 Go green.** Propane appliances can dramatically slash greenhouse gas emissions and earn you points under green building programs such as the National Green Building Standard™ and LEED (Leadership in Energy and Environmental Design) for Homes.

[buildwithpropane.com](http://buildwithpropane.com)

202.452.8975

[info@propanecouncil.org](mailto:info@propanecouncil.org)



**PROPANE**  
EXCEPTIONAL ENERGY®

Propane Education & Research Council  
1140 Connecticut Ave. N.W., Suite 1075  
Washington, DC 20036

© Propane Education & Research Council 7/09

The Propane Education & Research Council was authorized by the U.S. Congress with the passage of Public Law 104-284, the Propane Education and Research Act (PERA), signed into law on October 11, 1996. The mission of the Propane Education & Research Council is to promote the safe, efficient use of odorized propane gas as a preferred energy source.

